



PAKOLE

INSTRUCTIONS FOR INSTALLATION AND SERVICING

(For qualified persons)

AIR DESTRATIFIER VENTILATORS

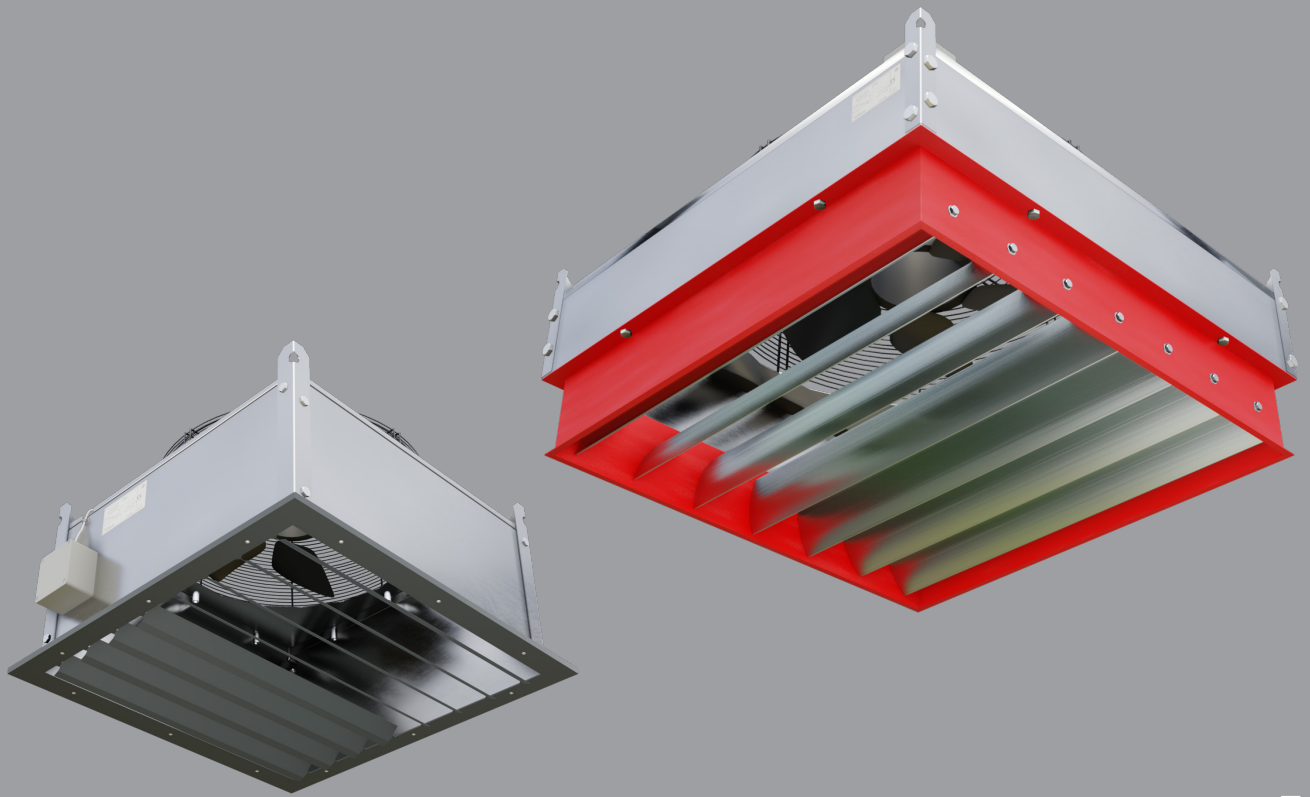

Appliance types:

LLV-400

LLV-450

LLV-500

LLV-650

LLV-800

LLV_008_036_011_220628_V004_EN

www.pakole.com

EN

CONTENTS

1. SAFETY INFORMATION	3
2. GENERAL INSTRUCTION	4
Data board	4
Installer's responsibilities	4
Corrosive materials	5
Standards and laws	5
Safety signs.....	5
Safe usage	5
3. TRANSPORTATION, UNPACKING, HANDLING	6
4. OPERATION PRINCIPLE	7
5. DEVICE DESIGN	7
The main components of air destratifier.....	7
Technical data	8
Direction of airflow.....	9
6. APPLIANCE INSTALLATION	9
Installation distances	10
Electrical connection	10
Connecting cable data	11
Electrical wiring	11
Connection of the speed controller	11
Decommissioning.....	12
Improper use	12
7. MAINTENANCE, CLEANING	12
Start up.....	13
Useful information	13
8. USING THE DEVICE	13
Starting and stopping the device.....	13
Fault or unsatisfactory operation.....	13
Operating	13
Cleaning the device.....	14
User periodic maintenance	14
Annual review.....	14
9. SERVICE	14
Replacement parts	14
10. PREVENTION OF ERROR	15
11. OPERATING LIMITS	15

1. SAFETY INFORMATION



ATTENTION! Read and understand this Installation and Maintenance Instruction before using the equipment! Keep this Installation and Maintenance Guide to answer any questions you may have later!

GENERAL SAFETY WARNINGS!

Failure to follow the warnings and instructions in the enclosed Installation and Maintenance Manual may result in serious injury or property damage.



The appliance may only be used by persons who have understood and followed the instructions in the Installation and Maintenance Manual! If you need help or information about the heater, such as installation instructions, contact the manufacturer.

This appliance is not intended for use by persons with reduced physical, sensory or mental capabilities, or lack of experience and knowledge, including children. Children should be supervised to ensure that they do not play with the appliance.





ATTENTION! The appliance must not be used at home!

2. GENERAL INSTRUCTION

- Make sure you have read and understood all the warnings, the exact observance of which guarantees safe and perfect operation!
- Always use caution when using the device! Follow the regional regulations and recommendations!
- Use the device only at the electrical voltage and frequency indicated on the nameplate! The electrical connections and earthing have been designed in accordance with EN 60335!
- Electrical grounding requirements: this appliance is equipped with a three-point (earthed) connector for your protection!
- Keep the unit away from the following strong impacts: wind, high-pressure water jet, rain or dripping water! The equipment cannot be used in outdoor!
- Always check the appliance for damage before starting it. Never use damaged equipment!
- Keep the appliance in its original condition, do not allow it to age!
- Do not use severely obsolete equipment!
- Hang the device from a stable surface that maintains its stability during operation despite the device warming up!
- If the appliance is not used, always disconnect it from the power supply!
- Never block the air intake and exhaust vents!
- Never service equipment that is in operation or under electrical load!
- Never attach an air duct element to the front or back of the appliance that is not approved by the manufacturer!
- Use only original spare parts approved by the manufacturer, do not install replacement parts with the same operating characteristics as the original part. Such replacement parts can cause serious damage to the operation of the system!

DATA BOARD

The device is equipped with a data board, which is located on the outside of the device. The data board contains information on the type of appliance, the type of gas and the electrical connection. For example:

Manufacturer PAKOLE Trade Kft. 8000 Székesfehérvár, Börgöndi út 8-10.	Type LLV-650	  2806 20 <small>Date/place of production</small> 15.02.2021
IP protection: IP40	Airflow: 19400 m³/h	
Electrical connection: AC 230V, 50Hz, 1 Ph.	Electrical power: 0,75 kW	
Max.current entry: 14 A	Targeted country: GB	
Series number: 102-9334-135		

1. figure: Data board

INSTALLER'S RESPONSIBILITIES



THE DEVICE HAS BEEN MANUFACTURED IN ACCORDANCE WITH DIRECTIVE 2014/35/EU.

- Construction of electrical connections in accordance with regulations,
- installation of the device according to the arrangement specified in this manual,
- installation in accordance with fire protection regulations,
- providing materials for installation (not included in the device),
- performing the service, providing the Owner with a copy of this Manual,
- ensuring satisfactory air circulation around the device,

CORROSIVE MATERIALS

! ATTENTION! Do not use the device in a place where there may be corrosive substances in the air!

The manufacturer accepts no liability for damage to the device if it has not been installed as described above. This responsibility is entirely the responsibility of the person performing the design. To avoid such possibilities, if you are not sure about the fit to the building or activity, ask our staff for help.

The owner(s) and the person(s) coordinating the installation must identify any gaseous or solid substances present in the space to be heated which may be present in the building and which could significantly affect the operation or service life of the appliance (combustible materials, corrosive substances, halogenated hydrocarbons, etc.) and then,

STANDARDS AND LAWS

All devices must be installed in accordance with laws and standards. These laws refer to electrical wiring (there are special regulations for parking garages, aircraft hangars, etc.).

SAFETY SIGNS

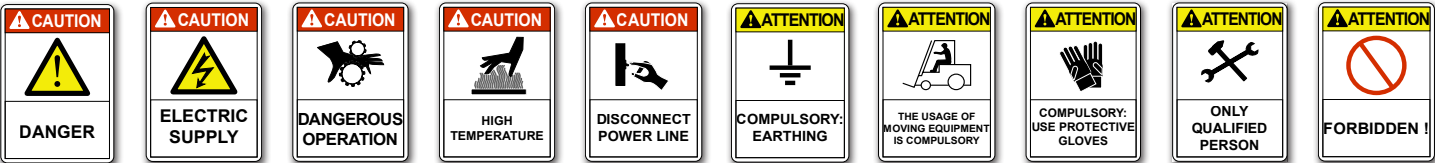

SAFE USAGE



- Observe the following relevant rules during installation, adjustment and service:**
- In all cases, the standards, regulations and country-specific regulations of the country of installation must be strictly observed during installation.
 - Installation and maintenance of the device may only be performed by a qualified person.

A **qualified person** is any person who has significant technical experience in the field of heating and ventilation installation and / or has a professional examination in the field, as well as has participated in the mandatory annual training organized by manufacturer. Call your nearest reseller for information.

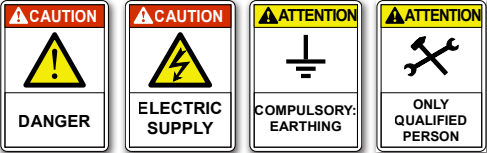

- Depending on the design, install the electrical wiring system.
- Before starting the appliance, always make sure that the appliance and its electrical components are properly earthed.



- Use protective gloves when disassembling the equipment.
- Watch out for sharp corners!
- Always keep the fan clean!

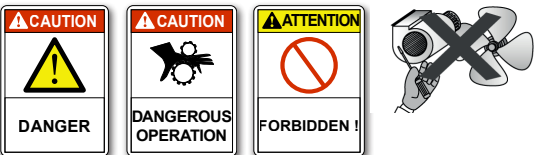

- Before cleaning or maintenance operations that can be performed by the customer (see chapter 8), after disconnecting the power supply, make sure that the fan has stopped rotating automatically. (Do not stop the still running fan by hand or other means!)
- The fan can reach 1000 rpm so don't put anything in the way of the blades.

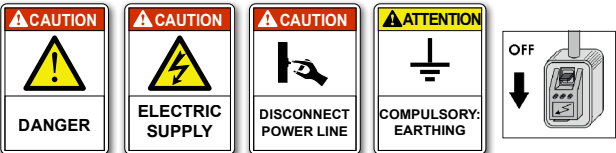

- We recommend that you install a separate, easily accessible disconnect switch near the machine to easily unplug the machine. Always unplug the appliance before cleaning or servicing.
- Before opening the appliance, make sure that all its components have been electrically disconnected from the mains. Take special care to make sure that the fan is stationary and cannot start during the installation process.

CHECK EARTHING !!



- When used in the vicinity of persons with reduced mobility, the device must be placed at a suitable, inaccessible distance from these persons.
- Improper installation can cause environmental or personal damage. The manufacturer is not responsible for damage resulting from such faulty installation.
- Furthermore, the manufacturer cannot be held responsible for damage resulting from incorrect, improper use.



- Never use the appliance in connection with another appliance.
- Never leave tools or accessories inside or on top of the appliance.
- Do not place the device in a flammable environment.



- In the event of a malfunction, do not attempt to service the device, call your distributor immediately.
- If you want to leave the unit turned off for an extended period of time, make sure that it cannot harm anything or anyone under any circumstances.

3. TRANSPORT, UNPACKING, HANDLING

- The transport must be carried out as follows :
 - Packages must be properly secured in the hold.
 - Packages should be transported protected from the weather, preferably in a closed hold.
- The device is equipped with special transport packaging suitable for transport, which must be kept in good condition until the date of delivery to the installation site.
- Check that the device contains all the parts and accessories included in the order.
- Check that the appliance is not damaged and that its type corresponds to the type ordered. All devices are shipped from the factory after testing, so if you notice any damage, notify your carrier immediately.

Transporting, unpacking and packing the device is a process that must be carried out with special care to avoid possible damage. Do not attempt to use the components of the device as a handle. When lifting, make sure that the center of gravity of the package is at the center of the lifting fork of the lifting machine.

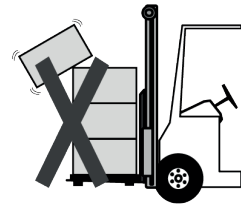

The device is delivered in a corrugated box, sometimes on a one-way pallet. The process of unpacking the device:

- remove the device and assembly materials from the paper boxes,
- inspect the device for damage during shipping.
- if the device is damaged, notify the dealer from whom you purchased the device immediately!

You will find the Installation and Maintenance Guide next to the machine, the Instructions Manual and the Letter of Warranty and the Commissioning Protocol.

The identification label that is affixed to each device contains the following information:

- Manufacturer details,
- Product type, serial number,
- Technical data.

4. OPERATION PRINCIPLE

The device works on the principle of air circulation, which blows hot air accumulated in the upper third of the room back into the living zone, thus reducing heating losses due to air stratification.

The device has a control electronics that allows two control modes. In automatic mode, if the preset temperature (25 ° C at the factory) reaches the air temperature at the unit, the fan will start and blow down the above warm air. In manual mode, the device can be started at any time with the help of a switch, so the device can also be used for ventilation and air circulation.

The direction of the blow-out can be set within certain limits using the lamella on the device. It is recommended to use an air technic specialist to determine the installation location of the device and to set the exact direction of the blow-out.

5. DEVICE DESIGN

THE MAIN COMPONENTS OF AIR DESTRATIFIER

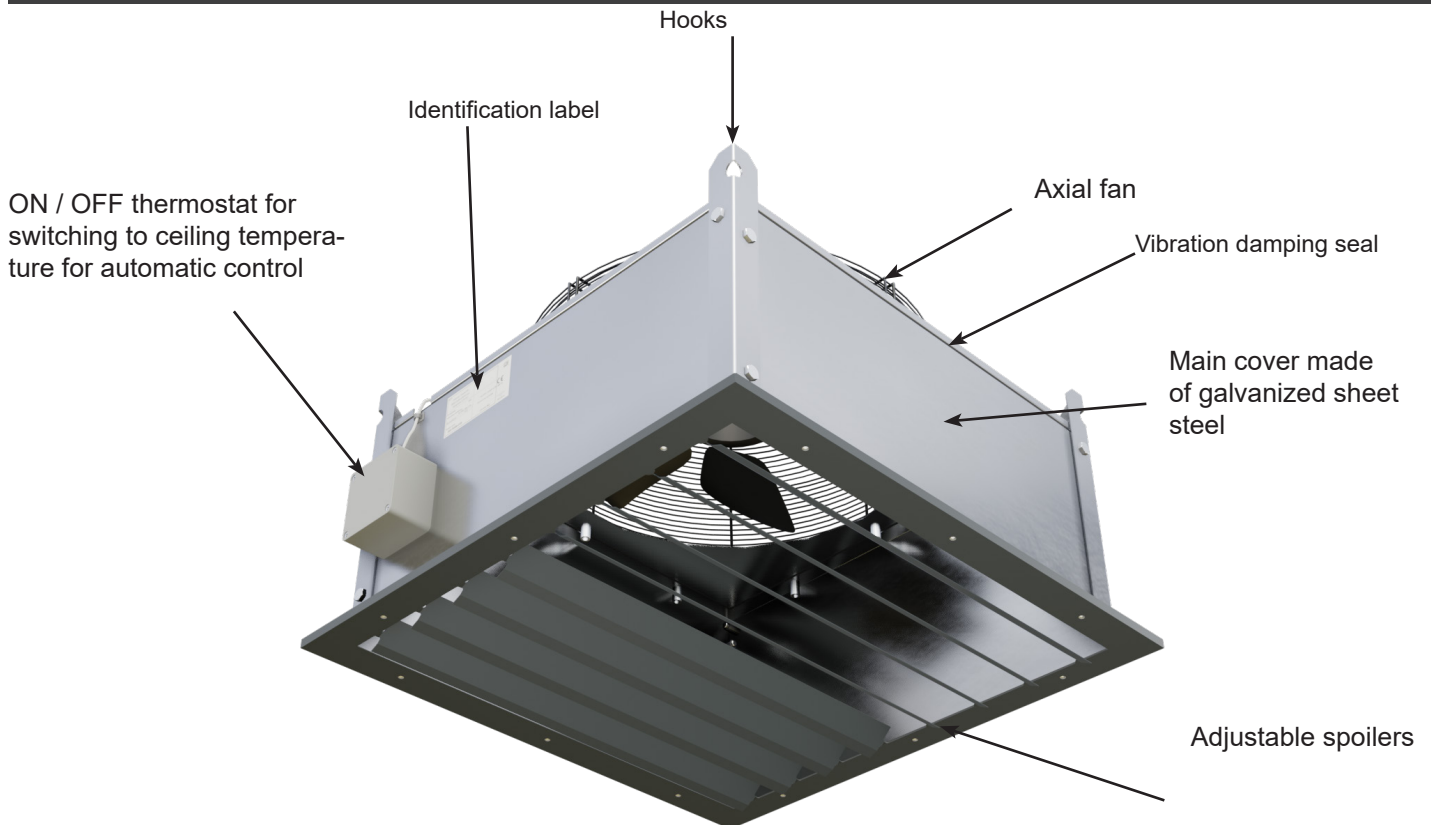

2. figure: The main components of air destratifier

TECHNICAL DATA

LLV-400 / LLV-450 / LLV-500

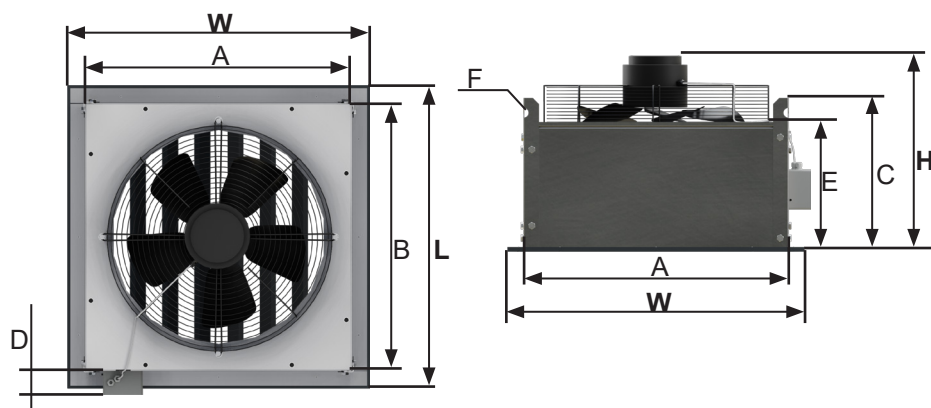

3 figure: LLV-400 / LLV-450 / LLV-500 device dimensions

LLV-650 / LLV-800

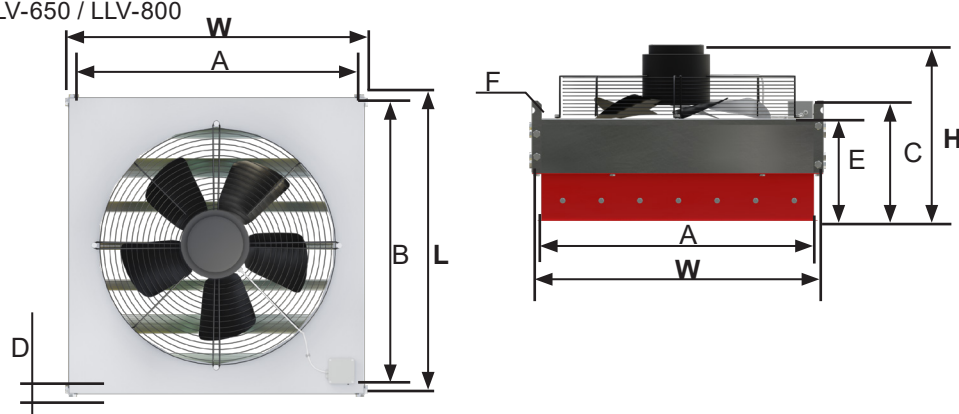

4 figure: LLV-650 / LLV-800 device dimensions

TYPE			LLV-400	LLV-450	LLV-500	LLV-650	LLV-800
Air transport		m ³ /h	3541	4620	6420	11435	10580
Noise level		dB(A)	68	68	72	75	78
Work place	S	m ²	100	160	230	310	450
Installation height	H	m	4-7	5-8	5-9	6-10	18-20
Ceiling distance	min. M	m	0,25	0,25	0,25	0,35	0,40
	recommended M	m	H/4	H/4	H/4	H/4	H/4
Revolutions per minute		1/min	1380	1350	1300	1360	906
Engine power consumption		W	180	250	420	750	1036
Power consumption		A	0,82	1,2	1,95	3,5	4,5
Electrical protection			IP40	IP40	IP40	IP40	IP40
Net weight		Kg	15,8	18,2	19,7	46,5	54
Electrical connection	230V-1Ph-50Hz						

Dimensions (mm)	LLV-400	LLV-450	LLV-500	LLV-650	LLV-800
W	600	663	663	780	930
L	600	663	663	930	930
H	~385	385	~385	~480	~515
A	538	608	608	750	885
B	538	608	608	885	885
C	313	313	313	380	380
D	56	56	56	56	56
E	268	268	268	320	320
F	14x21	14x21	14x21	14x21	14x21

DIRECTION OF AIRFLOW

The casing and lamella of the LLV 400-500 are also made of galvanized sheet steel, the lamella are painted. The slats can be unscrewed by hand, but their regular twisting can break the metal, so it is advisable to adjust the position of the slats well at first. The slats are bent on different sides on the right and left so that the air can be blown out in the Λ direction, this must be taken into account when bending the slats.

The LLV 650-800 devices use aluminium lamella with a plum seed profile, which can be adjusted freely along their axis. It is advisable to make the adjustment on the ground, before mounting, and to secure the position of the slats on both sides of the louvre frame by tightening the M8 nuts so that the high-pressure air does not turn them over.



Slats folded out in two directions at 30 °
For LLV 650-800



Slats extended in 45 ° in two directions
For LLV 400-500 devices

Type		LLV-400	LLV-450	LLV-500	LLV-650	LLV-800
Length of lamella	mm	515	590	590	850	850
Pieces of lamella	pcs.	2x4	2x4	2x4	5	7

6. APPLIANCE INSTALLATION



The device must always be installed inside the building!



INSTALLATION MUST ALWAYS BE CARRIED OUT IN ACCORDANCE WITH LOCAL LEGISLATION!

- Check that the equipment and its technical parameters correspond to the design of your choice and its documentation.
- Always keep the packaging items out of the reach of children as they may cause injuries.
- Always wear protective clothing before starting the installation and use suitable tools for the installation to avoid possible injuries. Before starting to install the unit, we recommend that you pre-install any optional components that follow the instructions in their assembly instructions.
- Select the installation location. When selecting, make sure that the mounting points of the device are connected to fixed, vibration-free batteries and can support the weight of the device.



- Mark the location of the 4 wall-plug on the floor.
- Make 4 holes for the wall-plugs.
- Secure the chains on which the device is suspended with 4 M8 tensioning screws or M8 threaded shanks. The use of a chain (min. 10cm) is required to absorb vibrations.
- The appliance must be installed in such a way that the openings cannot be blocked by either the air inlet or the air outlet side.

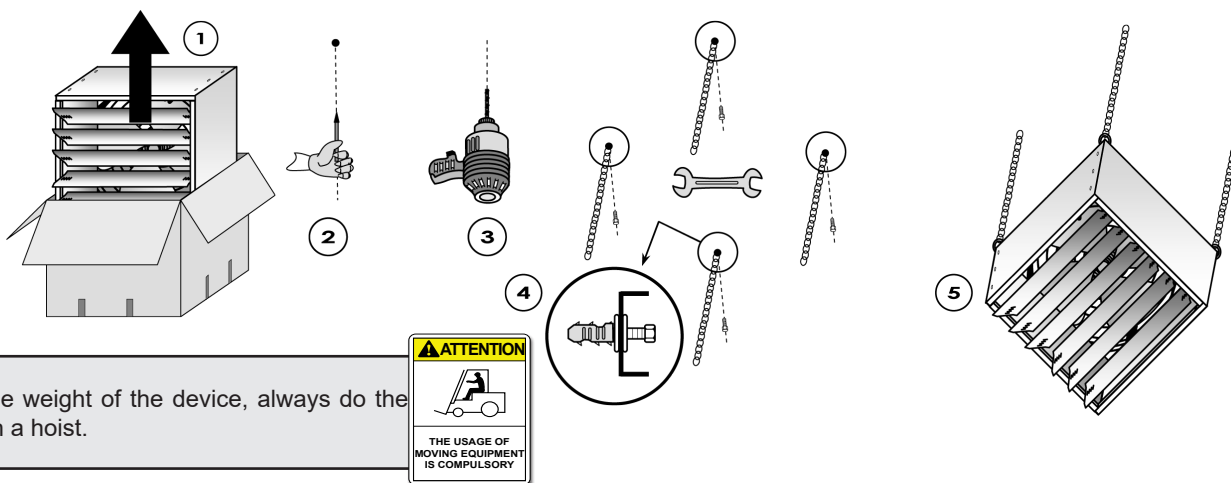

Due to the weight of the device, always do the lifting with a hoist.

INSTALLATION DISTANCES

The device must be installed in such a way that it is accessible for both general and special service!

In the case of under-ceiling installation, there must always be adequate space for testing the equipment.

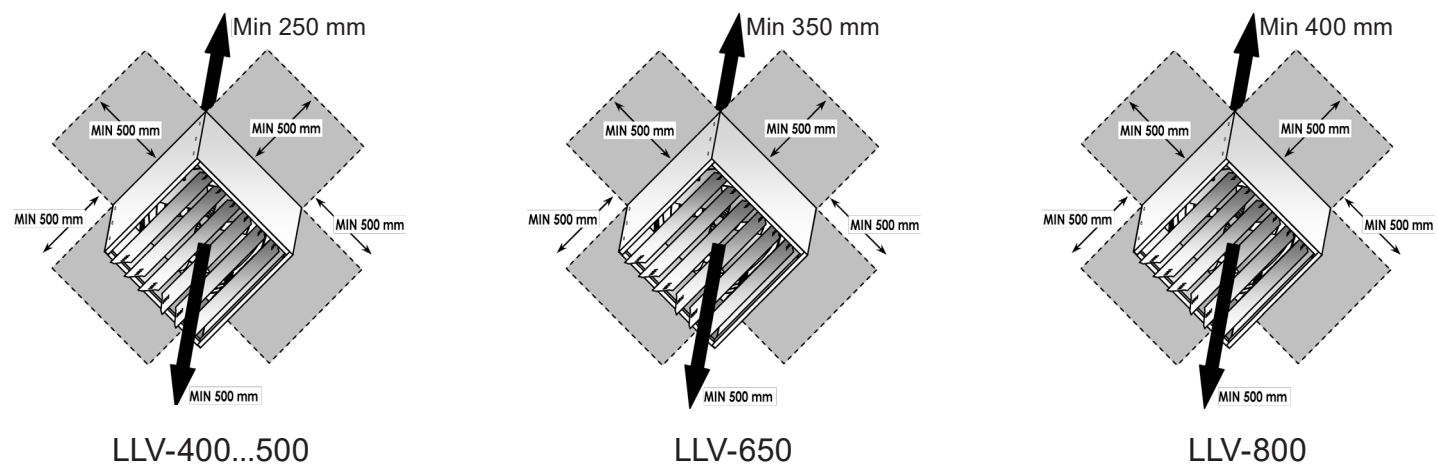

ELECTRICAL CONNECTION

ATTENTION: Before starting the electrical connection, make sure that the electrical connection to the appliance is disconnected.
ATTENTION: Electrical connection, installation and installation of accessories may only be carried out by a qualified person.
DO NOT FORGET: Electrical or any other modification to the product will void the warranty.

- Check the laws / regulations for your installation location.
- Check that the network specifications correspond to those on the rating plate of the appliance.
- Operation of the device other than from the network specified above will void the warranty.
- Verify that the electrical system can provide the additional power required to operate the new unit safely in addition to the existing equipment.

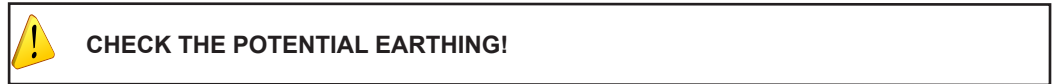
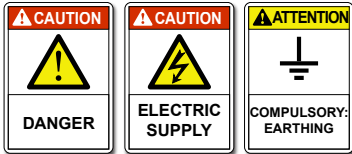

- Safe operation of the device is only established if it has been connected in accordance with the relevant safety regulations and is properly earthed.
- When making the connection, make sure that the earth cable is the longest so that it can be the last to break if the connection cable is tensioned, thus ensuring that the appliance is properly earthed.

CONNECTING CABLE DATA

When selecting cables, take into account the applied current and the relevant local regulations, and that no voltage drop of more than 3% is permitted on the line.

- Use H05V-K or N07V-K insulated wire that can be used up to 300/500V. All wiring not in the control box must be routed through a pipe or duct.
- Cables out of the pipe or duct must not be tensioned or twisted. They must be protected from moisture. The remaining wires can only be used to connect the finishing sections. Make sure all wires are connected properly.

ELECTRICAL WIRING

- Make the electrical connection according to the wiring diagram supplied with the device.
- The use of adapters, manifolds and extension cords is not permitted when connecting the main power cord.
- It is the responsibility of the installer to place the device as close as possible to the central power switch!!
- To prevent short circuits, the device must be connected to the mains by installing a multi-pole switch with a minimum opening of 3 mm. (check the current value on the rating plate on the appliance to select the correct switch). A multi-pole switch is actually a “bi-polar insulated switch”, meaning the switch is suitable for both voltage and 0-phase disconnection. This means that when the switch is off, both phases are disconnected. The multi-pole switch or socket must be installed in an easily accessible place.

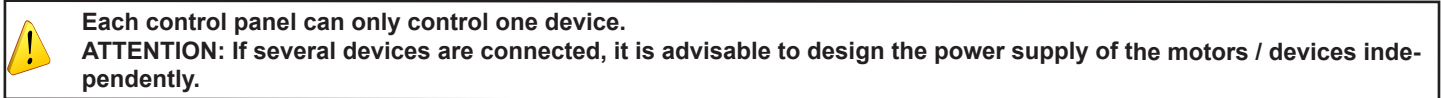

CONNECTION OF THE CONTROLLER



The electrical connection is located next to fuse 5A. Disconnect the plug and connect the 230V incoming cables to the appropriate connection points.

The connection points are as follows:

PE: potential earthing

N: null

L: phase (230V)

LV: direct input to fan for ventilation (230V)

ATTENTION! AT THE SAME INPUT “L” AND “LV” CANNOT BE PHASE, ONLY ONE CAN BE PHASE!

Optionally, a switch can be used to start the fan regardless of the temperature if the controller receives a phase at the **LV** input instead of **L**. This can be useful, for example, in summer or when it is necessary to ventilate the room regardless of the temperature, you can start the fan with a switch and then switch it back on for temperature-dependent control.

On the vertical auxiliary circuit has a blue potentiometer to control the temperature at which the fan turns on. It is set at 25 °C at the factory. The temperature on the knob can be set between 0 and 100 °C.

DECOMMISSIONING

- Disconnect the device from the mains via the multi-pole switch.

IMPROPER USE**NEVER TUG OR TWIST THE ELECTRIC CABLE!**

Never push, pass through, or secure the power cord with a nail or pushpin. A damaged cable can cause a short circuit or physical injury.

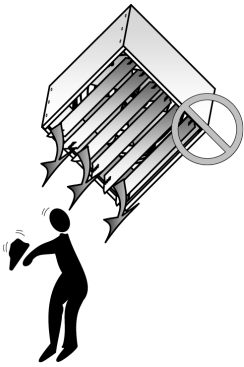
**APPROPRIATE EXHAUST POSITIONING**

The device must be positioned so that the escaping air does not reach people continuously.

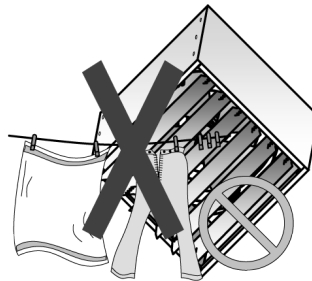

ATTENTION: When operating the appliance, do not place any objects or clothing in front of the air outlet, as this may block the air outlet and damage the appliance.

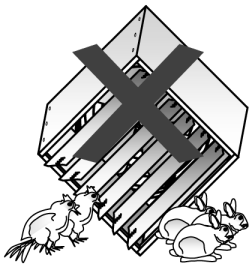
**IMPROPER USE CAN CAUSE DAMAGE**

The device must not be used in animal breeders or similar facilities. If necessary, a special (INOX) design can be solved to meet such needs.

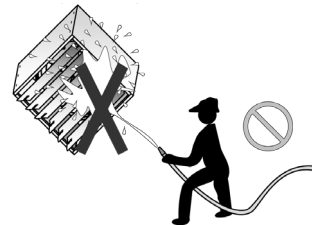

CLEANING THE APPLIANCE: Do not spray water on the unit as it may cause electric shock or damage to the unit. Do not use hot water, scouring powders or strong solvents for cleaning. Use a soft cloth to clean the device.

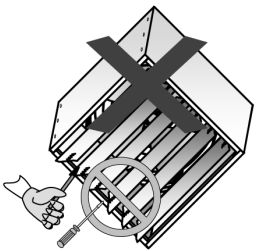
**DO NOT PLACE ANY OBJECTS IN FRONT OF THE BLOWER**

Never place any objects in the way of the blowers, as this may result in physical injury or damage to the unit.

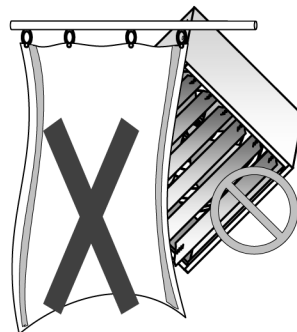

DO NOT COVER THE APPLIANCE WITH ANY OBJECT OR CURTAIN THAT COULD PREVENT FREE AIR FLOW.

DO NOT SIT ON THE DEVICE**7. MAINTENANCE, CLEANING**

- This device is made with modern technology, which ensures long-term efficient operation.
- It is important to establish a regular and specific inspection and maintenance program to maintain good condition at all times. The following maintenance program is designed to pay special attention to proper air quality and compliance with installation characteristics. Service time is highly dependent on adherence to the above. The most aggressive air-side condition occurs when the concentrations of industrial vapors, salt, chemical vapors, and rising dust in the air are particularly high.

START UP

 **ATTENTION!** Installation of the device and the relevant tests may only be carried out by a qualified person.

PLEASE CHECK THE FOLLOWING POINTS BEFORE INSTALLING THE EQUIPMENT:

- Mounting points for the device, on the ceiling, wall, etc.
- The accuracy of the connection and wiring points of the equipment .
- The available power supply.
- Fixing the mounting plates.
- Make sure that all standards, regulations and legislation for the installation of the devices have been complied with.

FOLLOW THE FOLLOWING STEPS TO COMPLETE THE INSTALLATION:

- Turn on the switch.
- Make sure that "TA" is set to the desired temperature with the under-ceiling control thermostat installed in the appliance to perform the automatic ON / OFF switch. ("TA" = adjustable up to 0 ÷ 100 °C, default: 25 °C)
- Switch on the appliance.
- After installation or after a long shutdown, it is recommended to operate the device at maximum speed for a few hours.

CHECK DURING INSTALLATION:

- Current and airflow.

USEFUL INFORMATIONS

It is recommended that the user be informed of all information necessary for proper operation, in particular the importance of periodic inspections, which must be carried out at least once a year by a qualified person.

8. USING THE DEVICE**STARTING AND STOPPING THE DEVICE**

- **ATTENTION!** Again, it should be noted that the installation and adjustment tests of the equipment may only be carried out by a qualified person. Failure to do so will void the warranty and the manufacturer will not be responsible for the safe operation of the equipment.
- Before starting the device for the first time, make sure that the installer has carried out the installation correctly.
- Avoid using unnecessary power when not in use.

FAULT OR UNSATISFACTORY OPERATION

In case of malfunction or unsatisfactory operation:

- Unplug the appliance.
- Do not attempt to service or repair this product yourself .
- Call a qualified service technician.
- Any type of service should only be performed by a service technician qualified by the manufacturer, using only original accessories.
- Failure to follow the above rules may endanger the safe operation of the device .

 **ATTENTION!** To ensure the efficiency and proper operation of the device, it is important that the necessary maintenance is performed by a qualified service technician according to the manufacturer's instructions.

OPERATING

 **The device can operate in different ways depending on the controller with which it is operated. Keep in mind, ALL CONTROLLERS MAY HAVE DIFFERENT OPERATING FUNCTIONS!! THEREFORE ALWAYS FOLLOW THE INSTRUCTIONS IN THE DESCRIPTION ACCOMPANYING THE REGULATOR.**

After installation or after a long shutdown, it is recommended to operate the device at maximum speed for a few hours.

CLEANING THE DEVICE



ATTENTION! Turn off the power before cleaning.

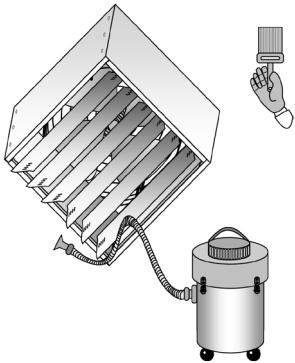

Do not spray water on the unit as it may cause electric shock or damage to the unit. Do not use hot water, scouring powders or strong solvents for cleaning. If possible, avoid operating the appliance while cleaning the room.

USER PERIODIC MAINTENANCE

NOTE: Regular maintenance ensures safe and economical operation!

- It is recommended to perform the following operations at the beginning of each cooling / heating season and at least once a month:
- Clean the outside of the machine with a damp cloth.
- **FAN MOTOR GROUP** (for all types): Both the motor and the fan operate with self-lubricating bearings that do not require additional lubrication. Make sure the fan is clean. If possible, use compressed air to clean the fan to avoid damaging the blades.

ANNUAL REVIEW

To keep the equipment in good condition, ensure that the maintenance is carried out by a qualified person at least once a year.

- Electrical unit check: check all electrical units and wiring are correct.
- Check all fastening connections that may come loose due to vibration .
- Check the fan motor for dust or other deposits. Check that the fan is running without vibration or noise, and that the suction or discharge flow is not obstructed to avoid overheating the motor winding.
- Check the fan housing for deposits or foreign matter.

9. SERVICE



ATTENTION! All installation-related activities as well as commissioning, etc. may only be performed by a properly trained technician.

You can request immediate technical assistance from your dealer or directly from the manufacturer, who will provide you with the contact details of the service partner closest to you.

Before requesting technical assistance, make sure that you have the technical data and the manual:

- Device type
- Serial number

Installation Confirmation Statement.



When replacing, the use of original spare parts is recommended for safety and quality reasons. To order parts, you will always need the device type and the component description.

REPLACEMENT PARTS

- If special technical solutions require the replacement of original parts, always consult a qualified technician.
- **ATTENTION!** When replacing parts, always make sure that the appliance is always switched off and disconnected from the mains and water supply.

10 PREVENTION OF ERROR



ATTENTION! Before opening the appliance, disconnect it from the mains via a multi-pole switch. If you notice any abnormality, do not delay, call the service center.

ERROR OCCURRENCE	POSSIBLE CAUSE-CONTROL-SOLUTION
Poor airflow	<ul style="list-style-type: none"> • Obstructed airflow (intake / exhaust side): Remove the obstruction • The fan rotates in the opposite direction: Check the wiring diagram and the connections
Excessive airflow	<ul style="list-style-type: none"> • Install the unit higher
Low static pressure	<ul style="list-style-type: none"> • The fan rotates in the opposite direction: Check the wiring diagram and the connections
High noise level	<ul style="list-style-type: none"> • Metallic elements are damaged: Check the condition of the metal elements and replace the damaged elements • Rotating parts are out of balance: Balance the fan blades • The suspension of the device is too rigid, so it transmits the resonance. It is recommended to use a longer chain.
Fan / motor not running	<ul style="list-style-type: none"> • Power failure: Check power supply and connections • Make sure: The mains is switched on • Make sure: Switches and controls are in the correct position • Make sure: There is nothing that blocks the rotation of the fan blades

11. OPERATING LIMITS

TYPE - MODEL	
Power supply (electric motor)	230V ± 15% / 1Ph /50Hz (Max 265V ; Min 195 V)
Power supply (control unit)	230V ± 15% / 1Ph /50Hz (Max 265V ; Min 195 V)
Temperature limits (ambient air)	-10°C ÷ +50°C
Humidity Limits (Ambient Air)	10% ÷ 90% rH (condensate free)

WARRANTY AND SERVICE

Keep this warranty card!

Type: _____

Serial number : _____

Date of purchase: _____

LIMITED WARRANTY *

The manufacturer warrants to the customer that the product and its components are free from defects in material and workmanship. The manufacturer guarantees the device for 2 years from the date of purchase, if it is operated in accordance with the regulations. This warranty applies to the first original retail customer.

The warranty covers the cost of laboratory tests and parts required for proper operation. Shipping and contingencies are also included in repair costs and do not include compensation costs.

Warranty repairs are only possible through an authorized dealer or service center.

The warranty does not cover damage resulting from improper use, damage, negligence, accident, lack of maintenance, normal wear and tear, modification, modification, factors affecting operation, use due to contaminated fuel, installation of unsuitable parts, repair by a non-service center or dealer.

Regular maintenance is the responsibility of the owner.

The manufacturer is not liable for any damage that may occur, either directly or as a result of improper operation.

***We reserve the right to change this specification without notice. The warranty is applicable based on the factors set forth above.**

We make no further warranty.

Warranty service

If your device requires service, this service can be taken to the nearest authorized service center. This service is included with the purchase agreement.

Repair service

Take the device back to the nearest authorized service facility. The cost of the non-warranty repair will be invoiced to the customer at the specified price. Service centers are independent of each other and may have other owners. We reserve the right to change this specification without notice.

Always have the device model and serial number available when you want to contact us.

For other information, please write to distributor.

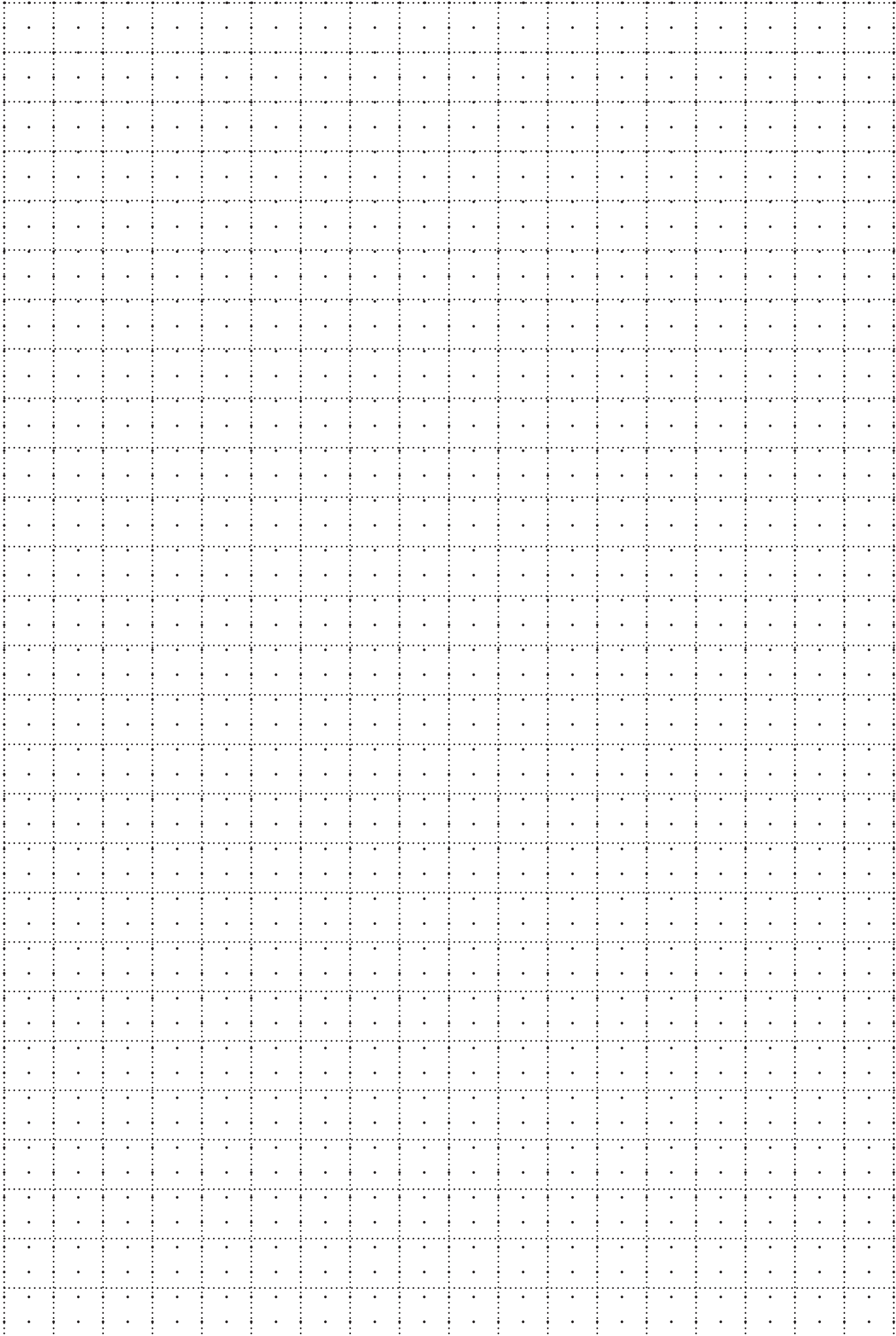



PAKOLE

www.pakole.com

PAKOLE TRADE Ltd.

H-8000 Székesfehérvár, Börgöndi út 8-10.

www.pakole.hu

mail@pakole.hu

Tel.: +36 22 316 484